

# 2008T Hemodialysis Machine with CLiC™ Device

## USER'S GUIDE

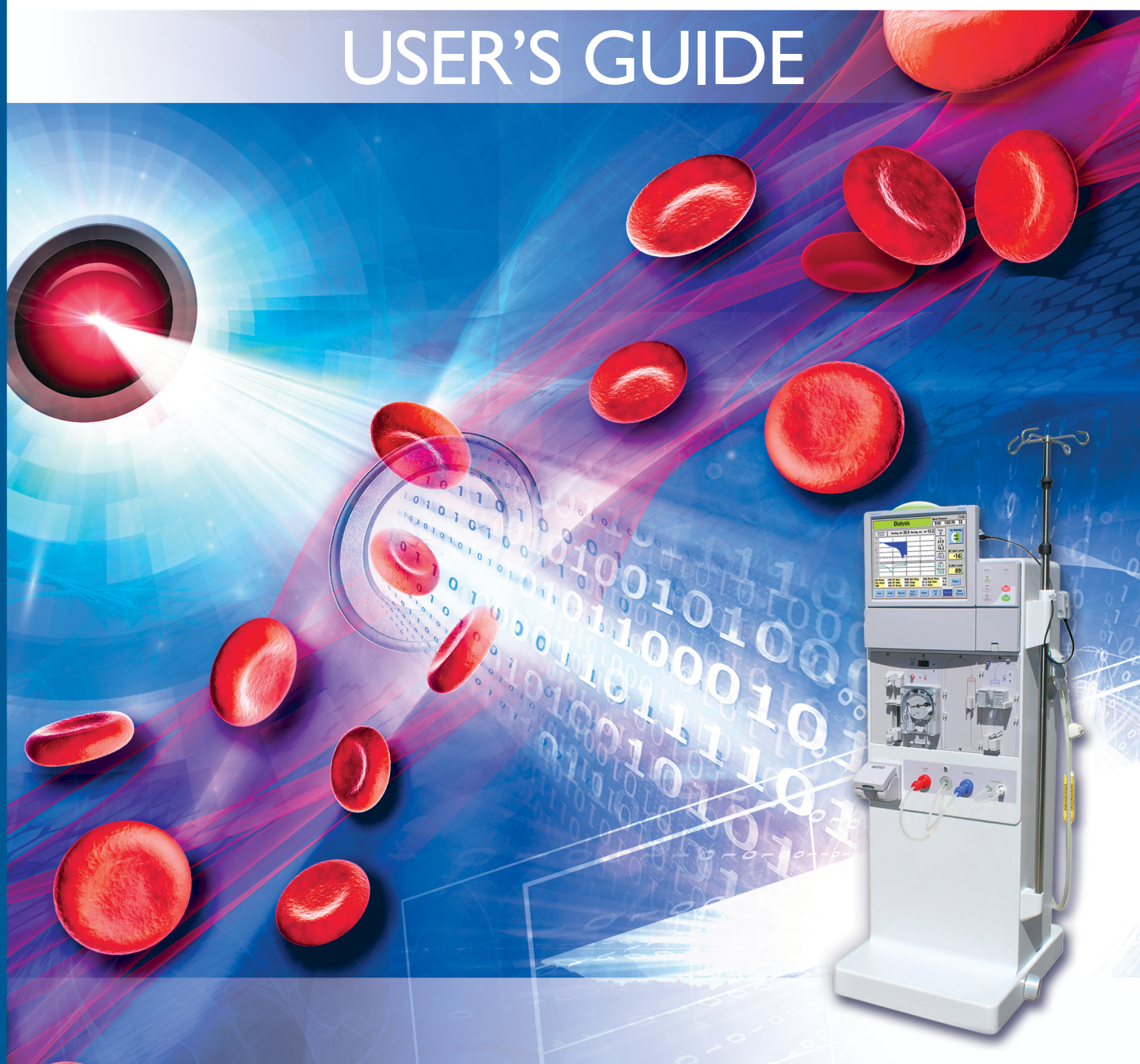



# 2008T Hemodialysis Machine With CLiC Device User's Guide

© Copyright 2014 - 2016, Fresenius USA, Inc.—All Rights Reserved

*This document contains proprietary information of Fresenius Medical Care Renal Therapies Group, LLC and its affiliates (“Fresenius Medical Care”). The contents of this document may not be disclosed to third parties, copied, or duplicated in any form, in whole or in part, without the prior written permission of Fresenius Medical Care.*

*Fresenius Medical Care, the triangle logo, 2008, DIASAFE, Crit-Line and CLiC are trademarks of Fresenius Medical Care Holdings, Inc., and/or its affiliated companies. All other trademarks are the property of their respective owners.*

*The 2008T hemodialysis machine is manufactured by:*

*Fresenius USA, Inc.  
4040 Nelson Avenue  
Concord, CA 94520  
(800) 227-2572*

*The CLiC device is manufactured by:*

*Fresenius USA, Inc. - Kaysville  
695 North 900 West  
Kaysville, Utah 84037  
(800) 546-5463*

*Contact Fresenius Medical Care Technical Support for applicable Field Service Bulletins. The spare parts manual for the model 2008T and other information may be found on our website at [www.fmcna.com](http://www.fmcna.com)*

**Caution:** *Federal (US) law restricts this device to sale only by or on the order of a physician.*

**Caution:** *Frequency, duration, and parameters of treatment are to be determined by the prescribing physician.*

**Note:** *Not all features are available in all regions.*

## **Indications for Use:**

### **2008T Hemodialysis Machine:**

*The 2008T hemodialysis machine is indicated for acute and chronic dialysis therapy.*

### **Crit-Line Clip Monitor (CLiC) (Optional):**

*The Crit-Line Clip Monitor is used with the 2008T Hemodialysis Machine to non-invasively measure hematocrit, oxygen saturation and percent change in blood volume. The CLiC device measures hematocrit, percent change in blood volume and oxygen saturation in real time for application in the treatment of dialysis patients with the intended purpose of providing a more effective treatment for both the dialysis patient and the clinician. Based on the data that the monitor provides, the clinician/nurse, under physician direction, intervenes (i.e., increases or decreases the rate at which fluid is removed from the blood) in order to remove the maximum amount of fluid from the dialysis patient without the patient experiencing the common complications of dialysis which include nausea, cramping and vomiting.*

*The CLiC blood chamber is a sterile, single use, disposable, optical cuvette designed for use with the CLiC monitor's sensor clip during acute and chronic hemodialysis therapy to non-invasively measure hematocrit, percent change in blood volume and oxygen saturation. The blood chamber is connected between the arterial bloodline and the dialyzer within the extracorporeal circuit during the hemodialysis treatment.*

# Table of Contents

Operating Instructions .....	3
General Warnings .....	3
2008T Hemodialysis Machine with CLiC Device Overview.....	4
Connecting the Crit-Line Blood Chamber .....	6
Connecting the CLiC Device to the Blood Chamber .....	8
Monitoring the Treatment from the “Crit-Line” Screen .....	10
Reading Graphs on the “Crit-Line” Screen.....	12
The Blood Volume (BV) Graph.....	14
The Oxygen (O <sub>2</sub> ) Saturation Graph.....	16
The Hematocrit Graph.....	18
The Blood Pressure Graph.....	20
Ending a CLiC Device Monitored Treatment.....	22
CLiC Device Care.....	24
Cleaning and Disinfecting the CLiC Device .....	24
CLiC Device Disposal.....	24
Troubleshooting.....	25
Service Mode .....	30
Enabling the CLiC device in Service Mode .....	30
Selecting the Crit-Line Graph Type .....	30
Calibrating the CLiC device.....	30
Appendix .....	31
Product Improvement Policy .....	31
Warranty.....	31
CLiC Spare Parts .....	32
Additional Information.....	32
Crit-Line in a Clip Specifications.....	33
Manufacturer’s Electromagnetic Compatibility (EMC) Declaration .....	34

## Operating Instructions

These instructions are for the optional CLiC device. The 2008T hemodialysis machine hardware must contain Functional Board software version 2.50 or greater. The CLiC device for the 2008T hemodialysis machine must only be operated according to these instructions.

For complete instructions on operating the 2008T hemodialysis machine, refer to the *2008T Hemodialysis Machine Operator's Manual* (P/N 490122).

## General Warnings



---

**Warning:** The values shown in pictures in this User's Guide are for example only. Parameters must be entered as prescribed by the patient's physician. Failure to enter correct parameters could result in serious injury or death.

---



---

**Caution:** The Crit-Line in a Clip (CLiC) device is a sensitive electro-optical device. Use special care when handling, storing, or cleaning the device.

---



---

**Note:** The CLiC device is only a tool used to complement a treatment on the 2008T hemodialysis machine. Operators must rely on their own clinical assessment of the patient to administer the treatment, as per the standard of care.

---

**Note:** If the 2008T hemodialysis machine displays the message "Crit-Line needs verification," the CLiC device must be verified for accuracy before using it to monitor the treatment. To verify the CLiC device automatically, clip the device on its verification filter, which is attached to its cable. After one minute, the CLiC should be verified.

To verify the CLiC device manually, go to the Dialysis Mode "Test & Options" screen, select the **Verify Crit-Line** button, and press the **CONFIRM** key. When an 'X' appears in the 'OK' field, the CLiC device has been successfully verified.

---

**Note:** The Crit-Line option must be set to "ON" in Service Mode in order to use the CLiC device during a hemodialysis treatment. The Blood Volume or Hematocrit graph option is also set in Service Mode. The Blood Volume graph is displayed by default.

---

**Note:** If the Crit-Line option is selected, the BTM and BVM module options are not available.

---

# 2008T Hemodialysis Machine with CLiC Device Overview

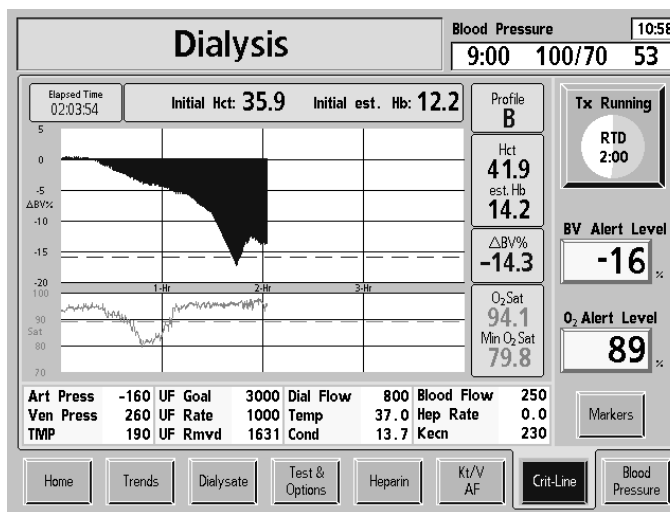

**2008T Hemodialysis Machine  
“Crit-Line” screen**

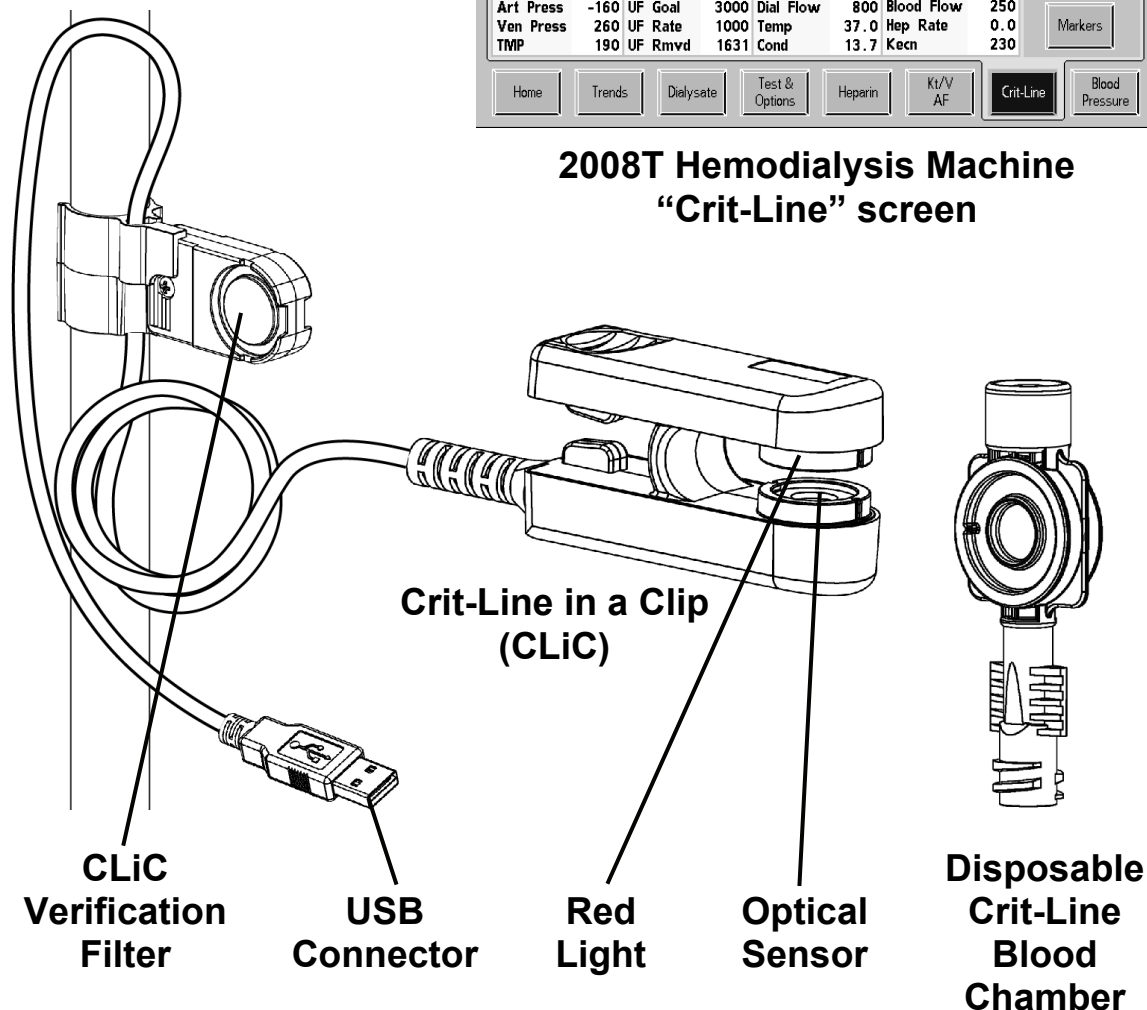

## **2008T Hemodialysis Machine with CLiC Overview**

The CLiC device is used to non-invasively measure a hemodialysis patient's hematocrit, oxygen saturation and percent change in blood volume. These measurements occur in real time in order to provide a more effective treatment. The measurements are displayed on the 2008T hemodialysis machine's "Crit-Line" screen. Under the direction of a physician, the clinician/nurse can increase or decrease the ultrafiltration (UF) rate in order to remove the maximum amount of fluid without the patient experiencing the common dialysis related complications which include hypotension, nausea, cramping and vomiting.

The system consists of software for the 2008T hemodialysis machine, a Crit-Line in a Clip (CLiC) device, a CLiC device-specific verification filter which is used to calibrate and verify the CLiC device, and a disposable Crit-Line Blood Chamber.

### **CLiC Device**

The CLiC device connects via a cable with a USB connector to the port on the right side of the 2008T hemodialysis machine display screen.

The CLiC device contains a sensor that monitors the patient's hematocrit, oxygen saturation and percent change in blood volume during dialysis. The CLiC device clips onto the Crit-Line Blood Chamber which is positioned between the arterial bloodline and the inlet port of the dialyzer. The CLiC device shines a red light through the lens of the Crit-Line Blood Chamber and onto a sensor on the opposite side of the blood chamber. This sensor detects the level of absorption and scattering of the red light as it is transmitted through the patient's blood, which flows through the blood chamber.

### **Disposable Crit-Line Blood Chamber**

The Crit-Line Blood Chamber is a sterile, disposable piece designed to ensure a consistent viewing area for the CLiC device sensor. This provides accurate, repeatable Hematocrit and oxygen saturation measurements.

### **CLiC Verification Filter**

The CLiC device features a verification filter unique to each CLiC device. The verification filter is used to periodically verify the accuracy of the CLiC device. The CLiC Verification Filter is attached to the CLiC device's USB cable. The CLiC device should be securely clipped to the verification filter when it is not in use.

When the CLiC device is stored on its verification filter, the 2008T hemodialysis machine automatically verifies the accuracy of the CLiC device when entering Dialysis Mode.

If the CLiC device is not stored on the CLiC Verification Filter, the device must be verified at least once per month.

# Connecting the Crit-Line Blood Chamber

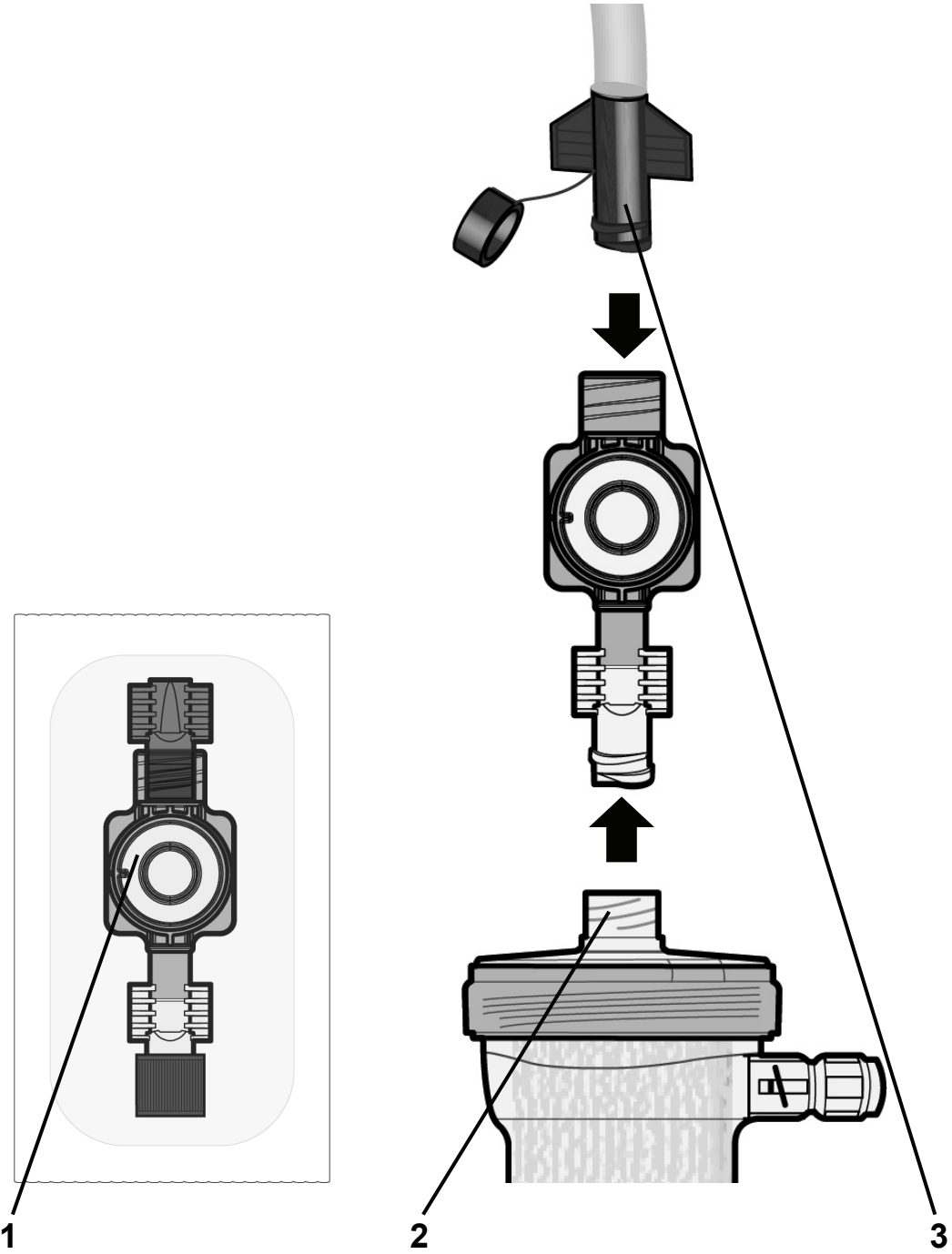



## Connecting the Crit-Line Blood Chamber

Follow these basic steps to attach the disposable Crit-Line Blood Chamber (P/N CL10041021) to the dialyzer during the extracorporeal bloodline setup before priming the bloodlines.



**Note:** The Crit-Line Blood Chamber is intended for single use only. A new sterile blood chamber must be used for each monitoring session.

---

### 1 Inspect Crit-Line Blood Chamber and packaging

Inspect the Crit-Line Blood Chamber and its sterile package prior to use. Refer to the blood chamber package label to ensure that the blood chamber sterilization has not expired.



**Warning:** Do not use the Crit-Line Blood Chamber if its package has been opened or its sterility has otherwise been compromised prior to use. The viewing area of the disposable blood chamber should be kept clean and free of obstruction.

---

### 2 Connect Crit-Line Blood Chamber to dialyzer

Remove the blood chamber from its sterile package and aseptically attach it to the arterial port of the dialyzer (as shown on the facing page). Make sure the connection is tight.

### 3 Continue setting up the bloodlines

Continue to set up the bloodlines as described in Chapter 2, “Connecting the Extracorporeal Blood Circuit,” in the *2008T Hemodialysis Machine Operator’s Manual* (P/N 490122).

When connecting the arterial bloodline to the Crit-Line Blood Chamber (not the dialyzer), hold the Crit-Line Blood Chamber securely in one hand and aseptically attach the dialyzer end of the arterial bloodline with the other hand. Be careful that you do not cross-thread the connection. The connection of the Crit-Line Blood Chamber to the arterial bloodline must not leak.



**Note:** Make sure that no air is in the Crit-Line Blood Chamber after priming. Any air present in the Crit-Line Blood Chamber will cause the hematocrit reading to be inaccurate.

---

# Connecting the CLiC Device to the Blood Chamber

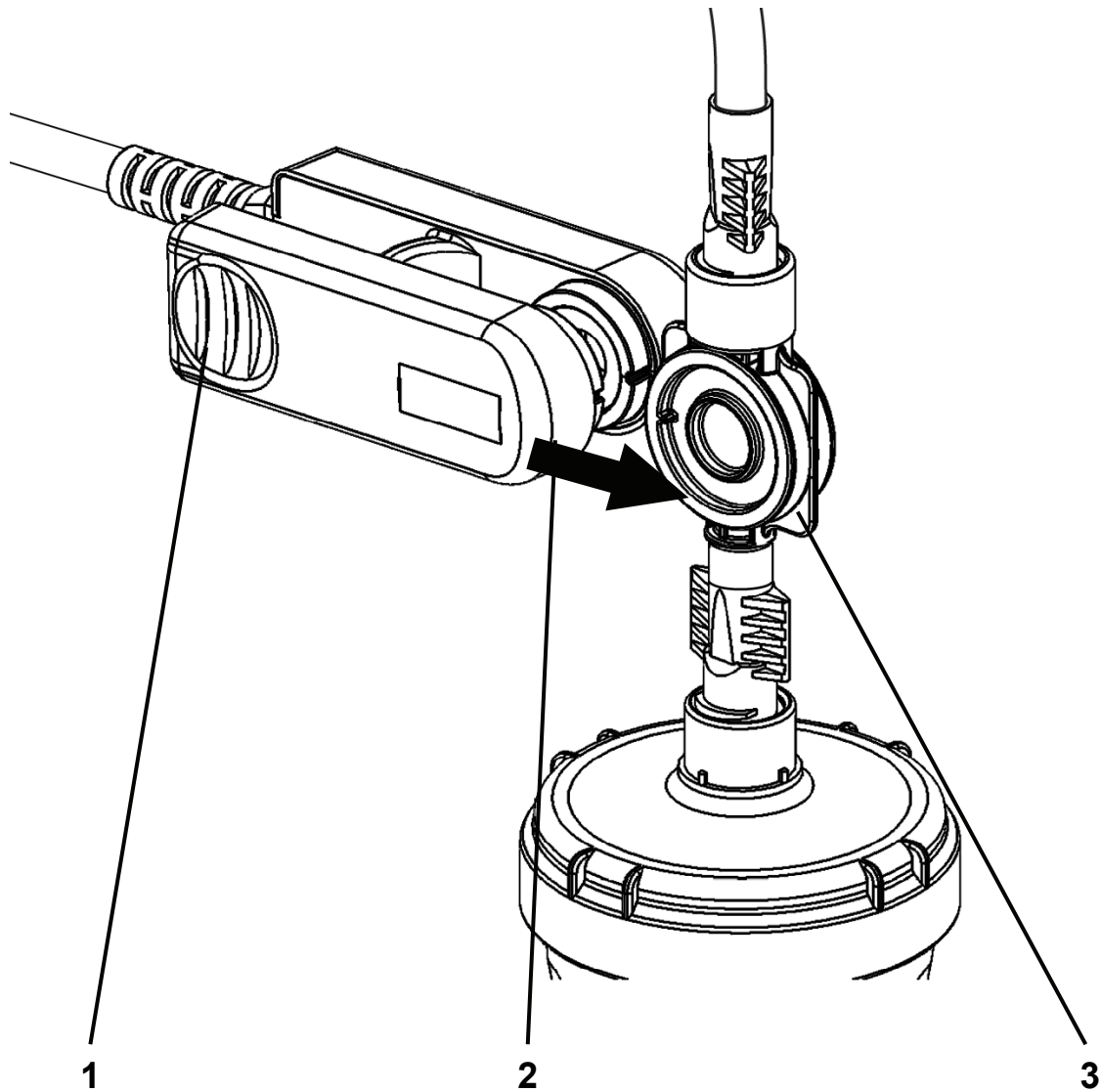

## Connecting the CLiC Device to the Blood Chamber

Follow the steps below to clip the CLiC device to the Crit-Line Blood Chamber (P/N CL10041021) before connecting to the patient's vascular access:

### 1 Pinch open the CLiC device

Hold the CLiC device such that one side is held by the index finger and other side held by the thumb. Squeeze the clip to spread the sensor elements apart.

### 2 Clip CLiC device on Blood Chamber



---

**Caution:** Before attaching the CLiC device, check carefully for leaks at the connections between the blood chamber and the dialyzer and the blood chamber and the arterial blood line. Improper attachment of the arterial bloodline to the Crit-Line Blood Chamber can cause blood or saline to leak onto and into the CLiC device. This can damage the CLiC device.

---



**Note:** Make sure that the CLiC device is plugged into the USB port located on the right side of the 2008T hemodialysis machine display screen.

---

1. Place the CLiC device over the Crit-Line Blood Chamber so that the optical sensor covers the lens of the Crit-Line Blood Chamber.
2. Release the clip to allow the optical sensor to seat on the viewing area of the Crit-Line Blood Chamber.
3. Make certain that the CLiC device has locked securely into place on the Crit-Line Blood Chamber by noting the audible and tactile click.
4. Ensure that the CLiC device is perpendicular to the top of the dialyzer and cannot be easily rotated up or down while attached to the blood chamber to ensure its proper placement.



---

**Note:** Make sure that the CLiC device is properly in place before starting the treatment. If the CLiC device is not properly seated on the Crit-Line Blood Chamber, the accuracy of the hematocrit and oxygen saturation readings may be adversely affected.

---

### 3 Check for proper blood flow before starting the Tx Clock

When starting the blood pump at the beginning of treatment, visually verify proper blood flow in the extracorporeal circuit, including the Crit-Line Blood Chamber, before starting the Tx Clock.

# Monitoring the Treatment from the “Crit-Line” Screen

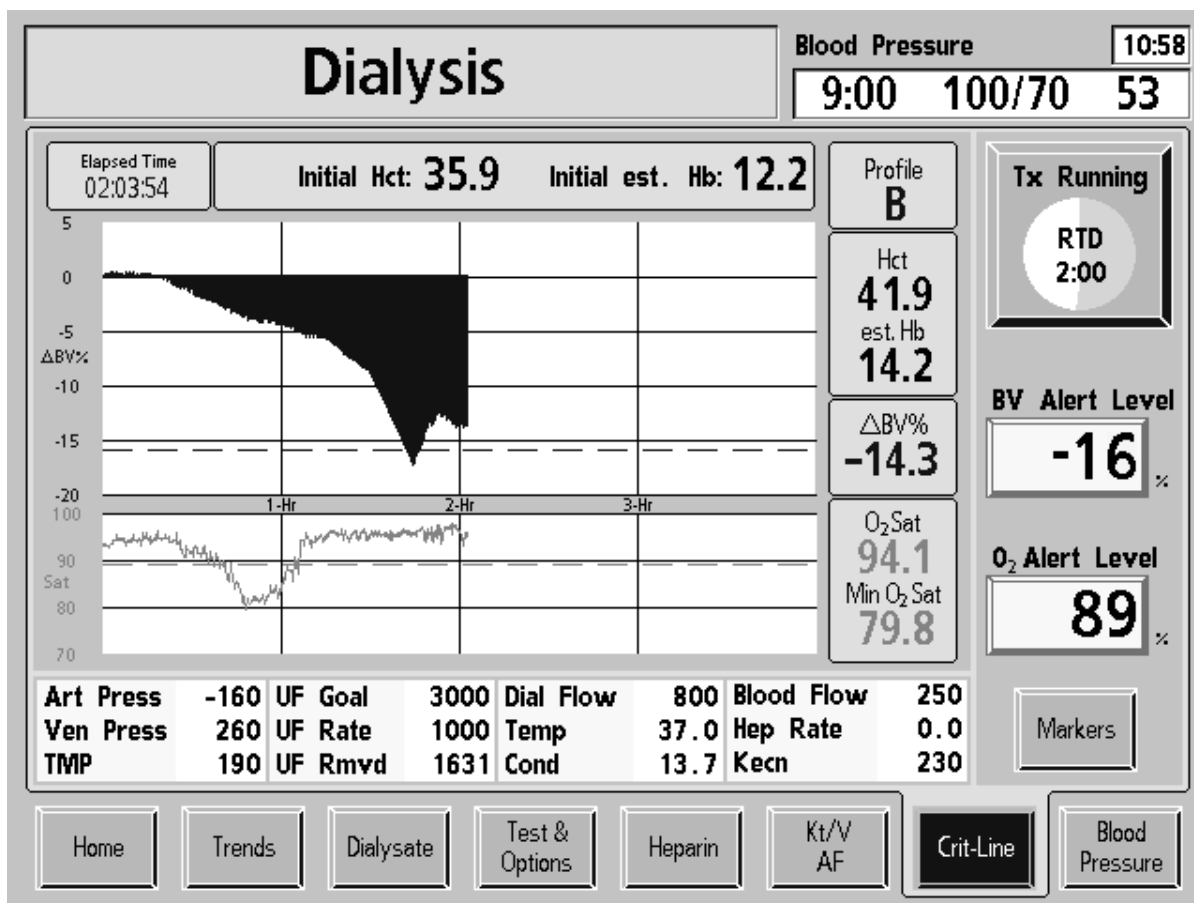



The “Crit-Line” screen showing BV and O<sub>2</sub> Sat graphs

## Monitoring the hemodialysis treatment from the “Crit-Line” screen

When the CLiC device is used for treatment with the 2008T hemodialysis machine, the “Crit-Line” screen replaces the “BTM BVM” screen. Most of the commonly viewed data from other screens are grouped on the “Crit-Line” screen for convenient monitoring.

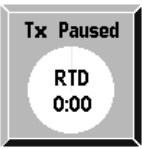
Listed below are the features of the “Crit-Line” screen that can also be found on other screens.

Feature	Description
Art Press	Arterial Pressure – The value displayed on the “Home” screen (mmHg)
Ven Press	Venous Pressure – The value displayed on the “Home” screen (mmHg)
TMP	TMP (Transmembrane Pressure) – The value displayed on the “Home” screen (mmHg)
UF Goal	UF Goal – The UF goal selected for the treatment and set on the “Home” screen (ml)
UF Rate	UF Rate – The UF rate selected for the treatment and set on the “Home” screen (ml/h)
UF Rmvd	UF Removed – The UF removed at a given point in the treatment and displayed on the “Home” screen (ml)
Dial Flow	Dialysate Flow – The dialysate flow rate selected for the treatment and set on the “Home” screen (ml/min). The dialysate flow rate can also be turned on or off from the “Dialysate” screen.
Temp	Temperature – The temperature of the dialysate as displayed on the “Home” screen (°C)
Cond	Conductivity – The conductivity of the dialysate as displayed on the “Home” screen (mS/cm)
Blood Flow	Blood Flow Rate – The current blood pump rate (ml/min)
Hep Rate	Heparin Rate – The heparin pump rate set on the “Heparin” screen (ml/h)  <b>Note:</b> As on the “Heparin” screen, this value will flash when the heparin pump is off unless both the “Heparin” screen <b>Rate</b> and <b>Infusion Time</b> buttons are set to 0 (zero).
Kecn	Kecn – The current Kecn (amount of sodium clearance) measurement. The Kecn is also displayed on the “Kt/V AF” screen’s “OLC Data” subscreen.
 	<p>Treatment (Tx) Clock – This button runs or pauses the treatment and displays the Remaining Time of Dialysis (RTD). The green segment of the pie chart represents the amount of treatment completed and grows as the treatment progresses. A <b>Tx Clock</b> button and an <b>RTD</b> button to set the RTD are also located on the “Home” screen.</p> <p>For a full description of these buttons, see the <i>2008T Hemodialysis Machine Operator’s Manual</i> (P/N 490122).</p>

# Reading Graphs on the “Crit-Line” Screen

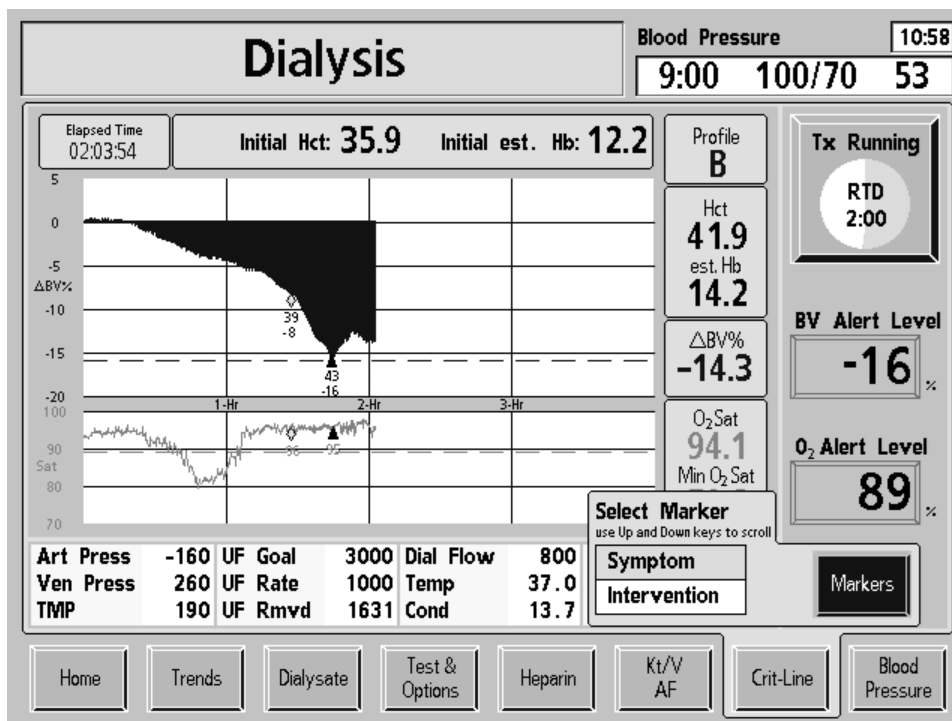

The “Crit-Line” screen showing BV and O<sub>2</sub> Sat graphs with markers

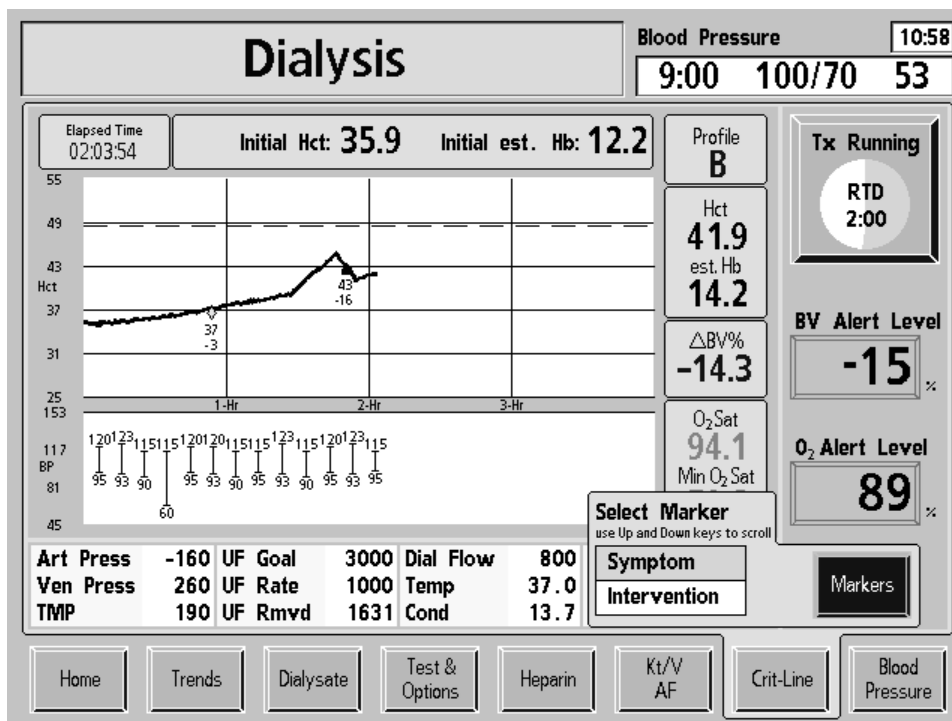

The “Crit-Line” screen showing Hct and BP graphs with markers

## Reading Graphs on the “Crit-Line” Screen







The “Crit-Line” screen can display either Blood Volume (BV) or Hematocrit (Hct) on the upper graph depending on the Service Mode setting.

On the lower graph, the Oxygen Saturation (O<sub>2</sub> Sat) graph can be changed to display blood pressures by selecting the graph and pressing the **CONFIRM** key.

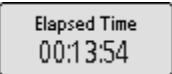
The BV and O<sub>2</sub> Sat graphs are displayed by default.

Graphing of the data begins after the CLiC device reads blood sensed and the hematocrit has been stable for sixty seconds with the Tx Clock and blood pump running. Graphs are displayed for a minimum of four (default) and a maximum of ten hours. The Hct and O<sub>2</sub> Sat graphs are resized vertically during the treatment depending on the min/max values and alert levels.

Listed below are features common to all graph displays:

Feature	Function
	Elapsed Time – The time the Tx Clock and CLiC device are running. If the Tx Clock is paused or an event pauses the treatment (such as blood alarms), then the Elapsed Time is paused along with CLiC device data collection.
	Initial Hct – The initial hematocrit (Hct) value is recorded along with the first data point when graphing begins.
	Initial est. Hb – The estimated initial hemoglobin (Hb) value is recorded along with the first data point when graphing begins. It is calculated based on the hematocrit reading.
	<p><b>Markers</b> button – Selecting this button displays a menu to insert an event marker on the BV (or Hct) and O<sub>2</sub> Sat graphs. Use the <b>↑</b> or <b>↓</b> (up or down) keys on the keyboard to select either ‘Symptom’ or ‘Intervention’. Pressing the <b>CONFIRM</b> key places the marker and the current <math>\Delta</math>BV%, Hct, and oxygen saturation values on the latest point on the graph; pressing the <b>Escape</b> key exits the menu without placing a marker.</p> <ul style="list-style-type: none"> <li>• The <b>Symptom</b> marker is displayed as a yellow diamond </li> <li>• The <b>Intervention</b> marker is displayed as a black triangle </li> </ul> <p><b>Note:</b> Markers can only be set at a minimum of ten minute intervals (depending on graph size) and when the Tx Clock is running and the CLiC device is not disabled. Resizing the graph may cause markers to rotate in order to better fit the space depending on the limits. If there is not enough space between markers, the machine will not place a marker in order to prevent overlap.</p>

# The Blood Volume (BV) Graph

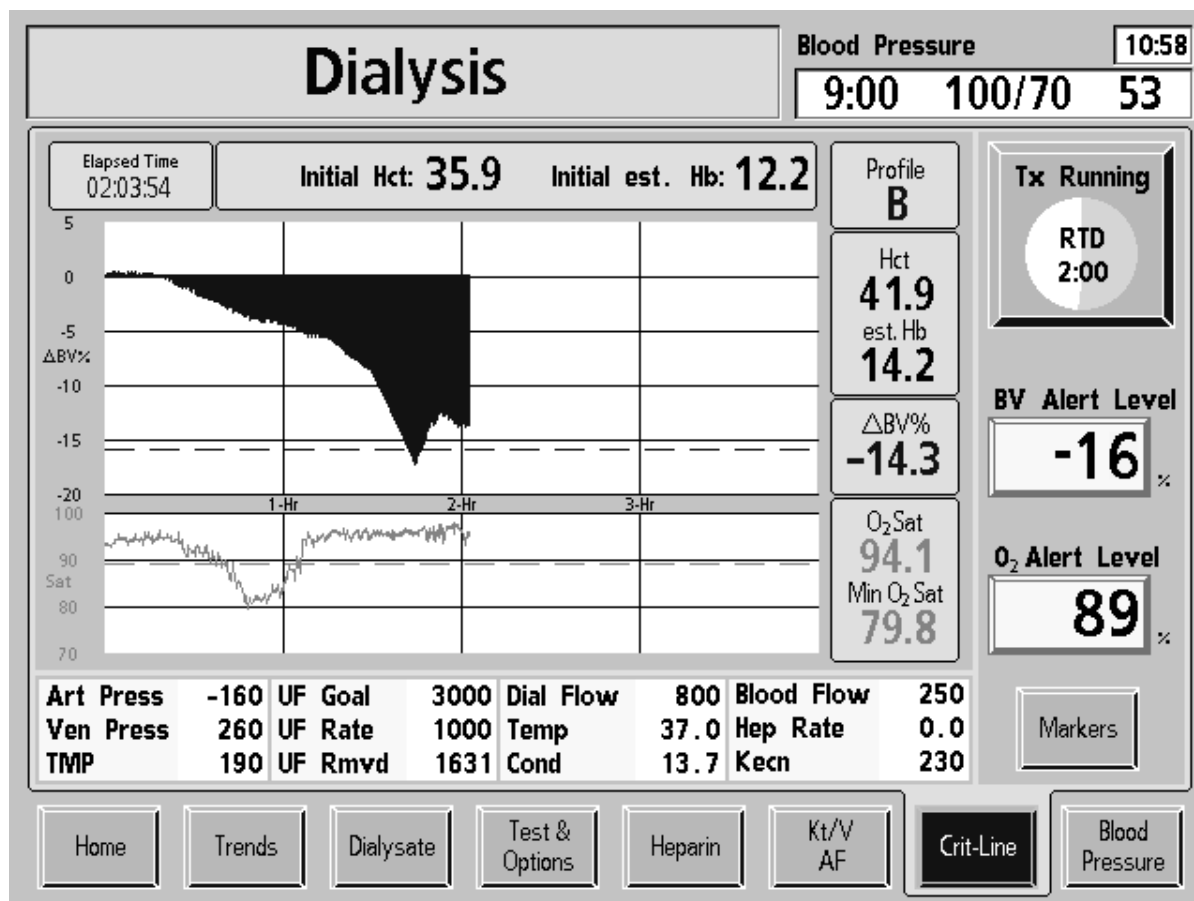

The "Crit-Line" screen showing BV and O<sub>2</sub> Sat graphs



## The BV (Blood Volume) graph



**Note:** The BV graph is the default upper graph displayed on the “Crit-Line” screen. To display the Hct graph instead of the BV graph, call a qualified service technician.

The BV (Blood Volume) graph is displayed as a fill graph. A line is filled from 0 to the  $\Delta BV\%$  value. As the dialysis treatment progresses, fluid is taken out of the blood by the 2008T hemodialysis machine’s ultrafiltration pump. This will result in a greater percentage of the blood being red blood cells and the blood volume fill graph will trend downwards and approach the alert level. The BV alert level is drawn as a blue dotted line across the BV graph.

The following is displayed to the right of the BV graph:

Feature	Function
	<p>Current blood volume change profile – The profile starts calculating after the first two blood volume measurements and is computed over the previous 15 minutes of data. The profile can be:</p> <ul style="list-style-type: none"> <li><b>A</b> BV change is less than or equal to -3% per hour (default)</li> <li><b>B</b> BV change is more than -3% and less than or equal to -6.5% per hour</li> <li><b>C</b> BV change exceeds -6.5% per hour</li> </ul>
	<p>Current Hematocrit value.</p>
	<p>Current estimated Hemoglobin value calculated from the current Hematocrit:  <math>Hb = Hct/2.94</math></p>
	<p>Blood Volume Change – The percent change in blood volume since the start of the treatment. The BV change value is calculated from the following equation:  <math>\Delta BV\% = [(Hct\ initial/Hct\ current) - 1] \times 100</math></p>
	<p><b>BV Alert Level</b> button – Sets the BV (Blood Volume) Alert Level (under physician direction). When the current <math>\Delta BV\%</math> drops below the set BV alert level, the 2008T hemodialysis machine stops the UF pump and displays the alert message “Rel. Blood Volume Low”. The alert can be cleared by lowering the alert level or by setting the BV Alert Level to OFF. After clearing the alert, the UF pump will automatically turn back on to the UF Rate set on the “Home” screen.</p> <p>To set the BV Alert Level, select the <b>BV Alert Level</b> button and enter the desired value using the <math>\uparrow</math> or <math>\downarrow</math> (up or down) keys or the numbers on the keyboard and press the <b>CONFIRM</b> key. To turn the BV Alert level OFF, enter “0” (zero) on the keyboard and press the <b>CONFIRM</b> key.</p> <p>The BV Alert Level can be set from -1 to -20 or 0 for OFF. The default setting is -15. The BV alert level is drawn as a blue dotted line across the BV graph.</p>

# The Oxygen (O<sub>2</sub>) Saturation Graph

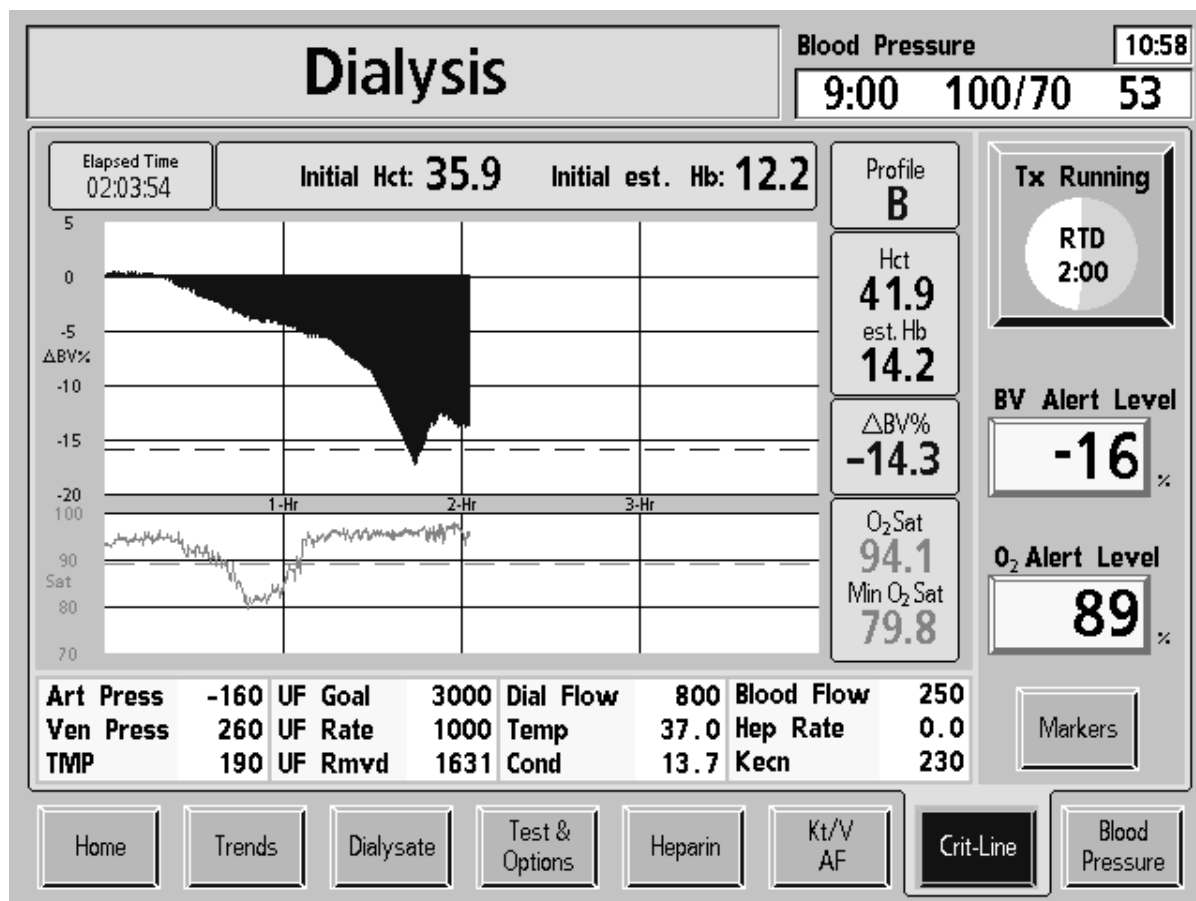

The "Crit-Line" screen showing BV and O<sub>2</sub> Sat graphs

## The O<sub>2</sub> Sat (Oxygen Saturation) graph

Oxygen saturation is the default display on the “Crit-Line” screen’s bottom graph.



**Note:** If blood pressure readings are displayed instead of the measured oxygen saturation, touch or select the Blood Pressure graph on the screen. The message “Press Confirm to switch to O<sub>2</sub> graph. Press Escape to return to BP graph.” is displayed. Press the **CONFIRM** key to confirm the selection. To switch back to the Blood Pressure graph, select the graph again and press the **CONFIRM** key to confirm the selection.

The O<sub>2</sub> Sat (Oxygen Saturation) graph is a line graph drawn from the previous oxygen saturation value. The O<sub>2</sub> Alert Level is drawn as a green dotted line across the Oxygen Saturation graph.

The following is displayed to the right of the Oxygen Saturation graph:

Feature	Function
	Current Oxygen Saturation value.
	Minimum Oxygen Saturation – The minimum oxygen saturation value over all data points.
	<p><b>O<sub>2</sub> Alert Level</b> button – This button sets the oxygen saturation alert level. When the current O<sub>2</sub> Sat value drops below the O<sub>2</sub> Alert Level, the alert message “Oxygen Saturation Low” is displayed in the Status Box. The alert can be cleared by lowering the alert level or by setting the O<sub>2</sub> Alert Level to OFF.</p> <p>To set the O<sub>2</sub> Alert Level, select the <b>O<sub>2</sub> Alert Level</b> button and enter the desired value using the <b>↑</b> or <b>↓</b> (up or down) keys or the numbers on the keyboard and press the <b>CONFIRM</b> key. To turn the O<sub>2</sub> Alert level OFF, enter “0” (zero) on the keyboard and press the <b>CONFIRM</b> key.</p> <p>The O<sub>2</sub> Alert Level defaults to 89 and can be set from 45 to 95. Setting the O<sub>2</sub> Alert Level to any value 44 or lower turns the O<sub>2</sub> Alert Level OFF.</p>

# The Hematocrit Graph

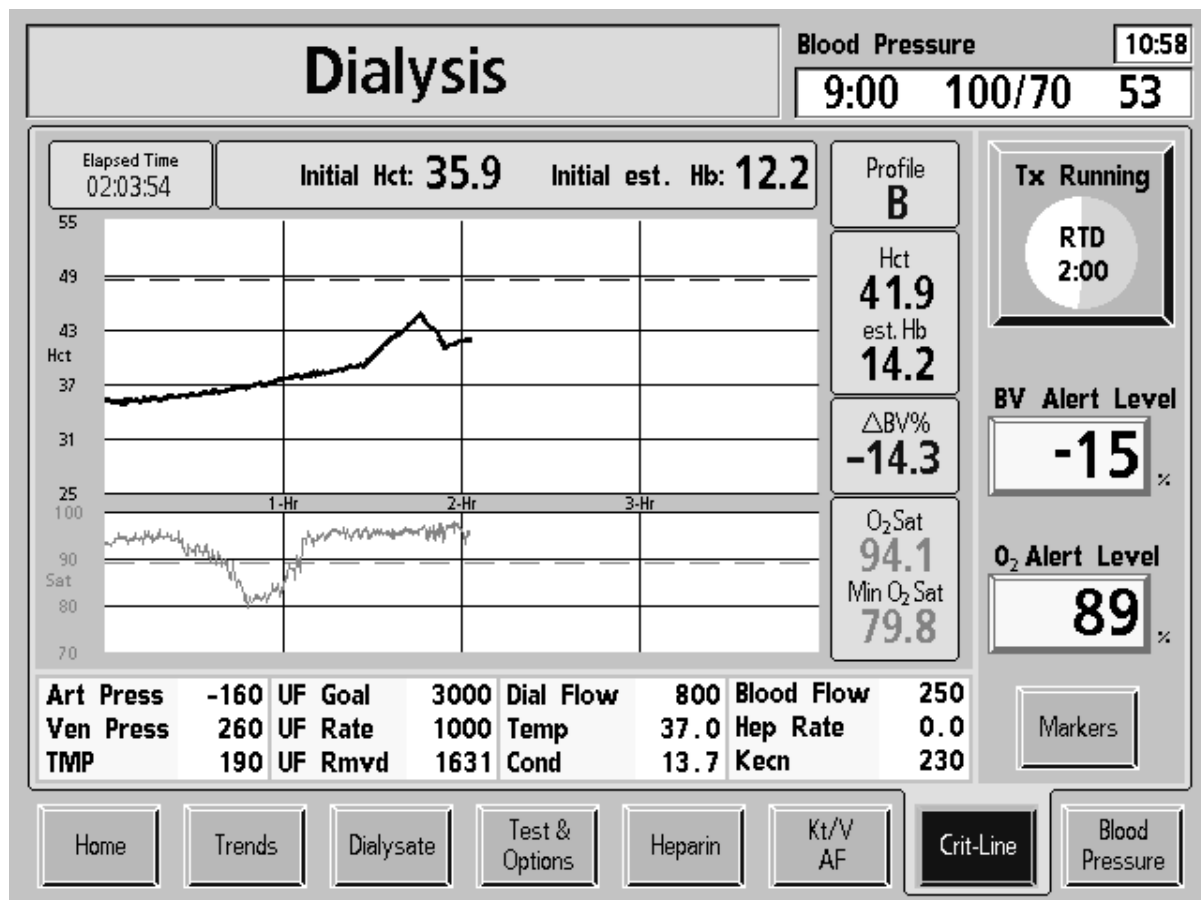

The "Crit-Line" screen showing Hct and  $O_2$  Sat graphs

## The Hct (Hematocrit) graph



**Note:** To display the Hematocrit graph on the “Crit-Line” screen instead of the default BV graph, call a qualified service technician.

The Hct (Hematocrit) graph is a line graph drawn from the previous hematocrit value. As the dialysis treatment progresses, fluid is taken out of the blood by the 2008T hemodialysis machine’s ultrafiltration pump. This will result in a greater percentage of the blood being red blood cells and the hematocrit line graph will trend upwards and approach the alert level.

The Hematocrit Alert Level is drawn as a black dotted line across the Hct graph. The Hematocrit Alert Level cannot be set directly, but is calculated from the BV Alert Level (see the **BV Alert Level** button, on page 15 for more information). The line will appear on the graph after the initial Hct is determined. When the alert is triggered, 2008T hemodialysis machine stops the UF pump and displays the alert message “Rel. Blood Volume Low”. The alert can be cleared by lowering the alert level or by setting the BV Alert Level to OFF. After clearing the alert, the UF pump will automatically turn back on to the UF Rate set on the “Home” screen.

To set the BV Alert Level, select the **BV Alert Level** button and enter the desired value using the **↑** or **↓** (up or down) keys or the numbers on the keyboard and press the **CONFIRM** key. To turn the BV Alert level OFF, enter “0” (zero) on the keyboard and press the **CONFIRM** key.

The following features pertain to the Hematocrit graph:

Feature	Function
Initial Hct: <b>35.9</b>	Initial Hct – The initial hematocrit (Hct) value is recorded along with the first data point when graphing begins.
Initial est. Hb: <b>12.2</b>	Initial est. Hb – The estimated initial hemoglobin (Hb) value is recorded along with the first data point when graphing begins. It is calculated based on the hematocrit reading.
Profile <b>A</b>	Current blood volume change profile – See page 15 for more information.
Hct <b>41.9</b>	Current Hematocrit value.
est. Hb <b>14.2</b>	Current estimated Hemoglobin value calculated from the current Hematocrit: $Hb = Hct/2.94$
$\Delta BV\%$ <b>-14.3</b>	Blood Volume Change – See page 15 for more information.

# The Blood Pressure Graph

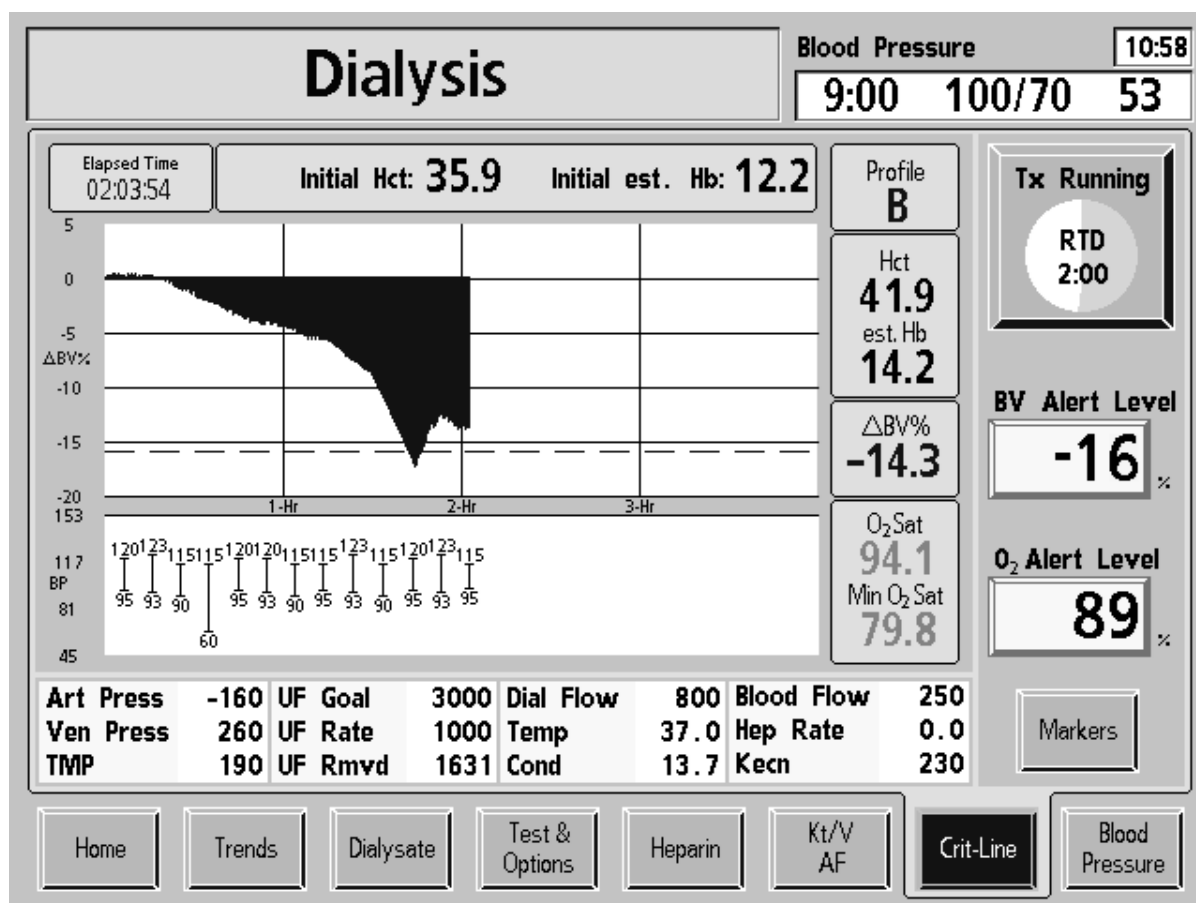

The "Crit-Line" screen showing BV and Blood Pressure graphs

## Displaying blood pressure on the “Crit-Line” screen

Blood Pressure readings can be displayed instead of the measured Oxygen Saturation. To change the O<sub>2</sub> Sat (Oxygen Saturation) graph to the BP (Blood Pressure) graph, touch or select the O<sub>2</sub> Sat graph on the screen. The message “Press Confirm to switch to Blood Pressure graph. Press Escape to return to O<sub>2</sub> graph.” is displayed. Press the **CONFIRM** key to confirm the selection.

To switch back to the O<sub>2</sub> Sat graph, select the graph again and press the **CONFIRM** key to confirm the selection.

## Reading the blood pressure graph on the “Crit-Line” screen

Similar to the Blood Pressure graph on the “Trends” and “Blood Pressure” screens, the BP (Blood Pressure) graph is drawn as a series of black dumbbells between the systolic and diastolic blood pressures. On the “Crit-Line” screen, the systolic (upper) and diastolic (lower) numbers are also displayed. If the value is out of range (as specified by the parameters on the “Blood Pressure” screen), the dumbbell will be drawn in red. Blood pressure readings are recorded only when the treatment clock is running.



---

**Note:** If there is not enough space between blood pressure measurements, the graph will not display a measurement in order to prevent overlap.

---

**Note:** Markers do not appear on the Blood Pressure graph.

---

# Ending a CLiC Device Monitored Treatment

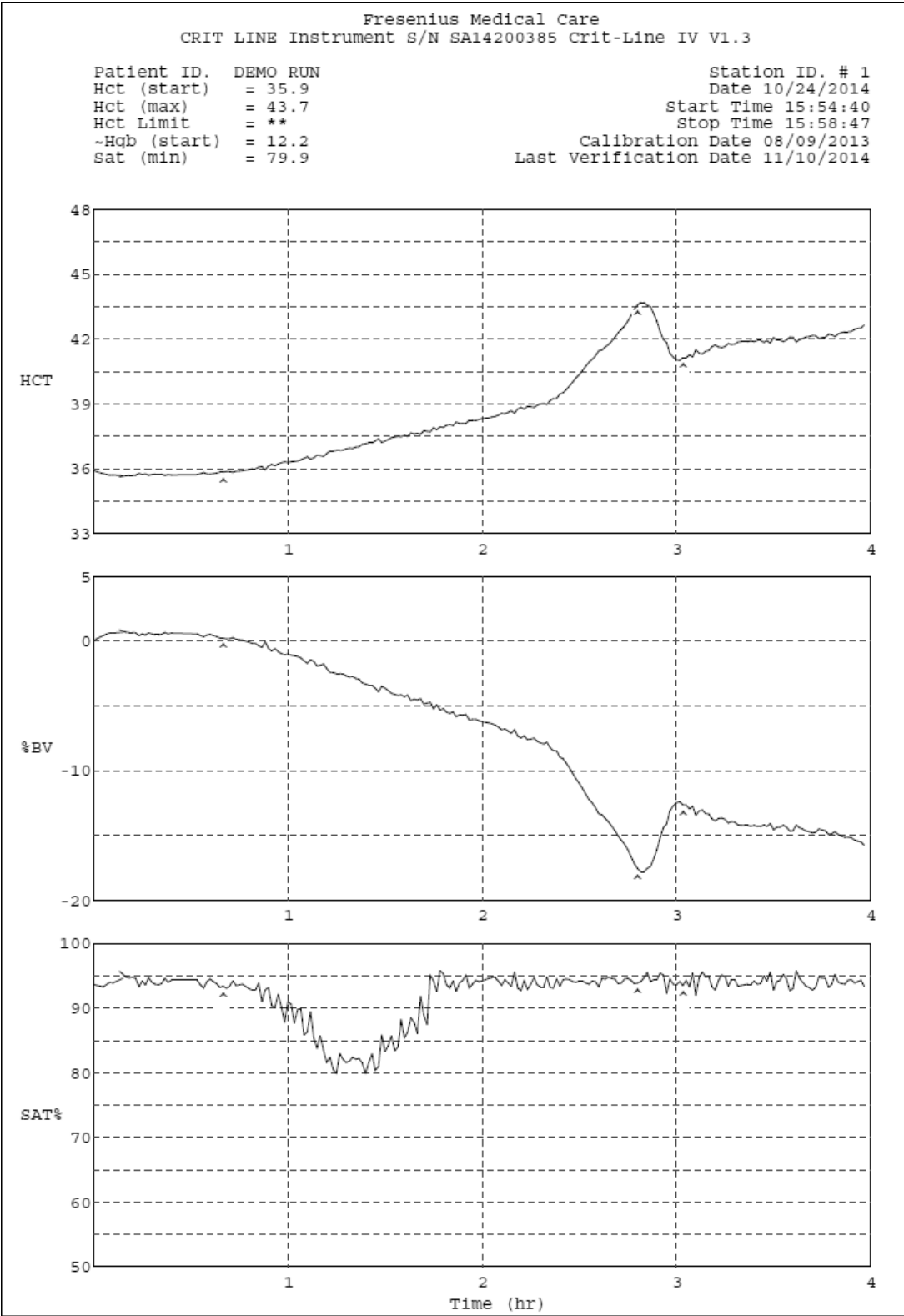



## Ending a CLiC device monitored treatment

When the treatment is complete and the Tx Clock is paused, pinch the CLiC device to spread the sensor elements apart and gently remove the device from the Crit-Line Blood Chamber. Store the CLiC device by clipping it to its verification filter, which is attached to its USB cable. Discard the disposable Crit-Line Blood Chamber with the rest of the bloodlines.

## Printing a treatment report

When RTD is zero and the Tx Clock is paused, a **Print** button will appear on the “Crit-Line” screen in place of the **Markers** button.

To clear the data on the “Crit-Line” screen without printing, press the **New Tx** key and then press the **CONFIRM** key.

See the “CLiC Spare Parts” section on page 32 for information on kits necessary to connect and use a printer.

The image on the facing page is an example of a CLiC device monitored treatment printout; below is an explanation:

Item	Description
S/N	The CLiC device’s four digit serial number (printed on the device’s verification filter).
Patient ID	The first 6 digits of the “Test & Options” screen Patient ID number. This is the unique identifier for this report. <b>Note:</b> If the Patient ID is fewer than 6 digits long, or if there is no Patient ID, this field will display six ones (“111111”).
Hct (start)	The initial hematocrit (Hct) value is recorded along with the first data point when graphing begins.
Hct (max)	The highest level of hematocrit during treatment.
Hct Limit	The hematocrit limit (indirectly set based on the BV Alert Level on the “Crit-Line” screen).
~Hgb (start)	The estimated initial hemoglobin (Hb) value recorded along with the first data point when graphing began.
Sat (min)	The minimum oxygen saturation value over all data points.
Station ID	Not applicable.
Date	The date of the treatment.
Start Time	The time the dialysis treatment began.
Stop Time	The time the dialysis treatment ended.
Calibration Date	The date the CLiC device was factory calibrated.
Last Verification Date	The last date the CLiC device was verified for accuracy in Dialysis Mode.
HCT Graph	Hematocrit graph
%BV Graph	Blood Volume graph
SAT% Graph	Oxygen Saturation graph

# CLiC Device Care

## Cleaning and Disinfecting the CLiC Device

The CLiC device is a sensitive electro-optical device. Use care when cleaning the device and the verification filter so as not to damage them. The exterior of the CLiC device, verification filter, and the 2008T hemodialysis machine should be cleaned after every treatment. These can all be cleaned with very dilute bleach or other suitable hospital disinfectant.

Freshly prepared dilute bleach solution (1:100) is currently recommended by the Center for Disease Control as a suitable disinfectant for the Hepatitis virus. Because surface contamination is the general mode of transmission for this type of virus, thorough cleaning of the exterior is essential.



---

**Caution:** Wipe the CLiC device with a cloth dampened with the cleaning solution; do not spray the solution on the device. Do not immerse the CLiC device in any type of liquid. If liquids infiltrate the device, they will damage it.

---

**Caution:** Do not use abrasive materials or solvents to clean the CLiC device. Doing so may damage the sensor.

---

**Caution:** Be careful not to scratch or damage the verification filter. If the verification filter is scratched or damaged, it may cause the CLiC device to fail the verification test.

---

If the CLiC device becomes contaminated with blood, it must be thoroughly disinfected before the next treatment. Freshly prepared dilute bleach solution (1:100) or surface disinfectants such as Cavicide or Enviroid can be used to disinfect the CLiC device.

## CLiC Device Disposal

If the CLiC device continues to fail the verification test even after recalibration, the device is no longer suitable for clinical use. Disinfect the CLiC device before disposing of it according to U.S. federal regulations 29CFR1910.145, 1910.1030 and appropriate state or local laws.

# Troubleshooting

The following troubleshooting section is a guide to help you troubleshoot CLiC device alerts, warnings, or advisory messages. For a complete list of 2008T hemodialysis machine messages, please see the Troubleshooting section of the *2008T Hemodialysis Machine Operator's Manual*, P/N 490122.

Messages shown in the 2008T hemodialysis machine software are listed alphabetically. These messages are triggered by conditions and events related to the use of the CLiC device that occur in the machine during operation. The messages will reset when the condition causing them is corrected. In some cases, you must reset them yourself.



**Warning:** Performing the recommended action may or may not clear the alert, warning or advisory messages displayed. An alert, warning or advisory message may stop the UF Pump until the conditions causing these messages are corrected and cleared. The dialysis treatment will continue during these messages.

---



**Note:** CLiC devices taken out of service should be tested and repaired by a qualified service technician.



---

**Note:** If you have any questions, please call Fresenius Medical Care Technical Support anytime at **(800) 227-2572**.

---

Message	Purpose of Message	Type	Action Required
<p>Check cable or press 'Y' to disable Crit-Line</p>	<p>The 2008T hemodialysis machine has not received data from the CLiC device. The Status Box displays the warning message "Crit-Line: No Comm"</p>	<p>Advisory message</p>	<p>Check the CLiC device's USB cable:</p> <ul style="list-style-type: none"> <li>• Make sure the cable is securely connected to the 2008T hemodialysis machine's USB port.</li> <li>• Wait up to one minute for the message to clear.</li> </ul> <p>If the Status Box warning message "Crit-Line: No Comm" is not cleared, the CLiC device cannot be used for the dialysis treatment.</p> <ul style="list-style-type: none"> <li>• Disconnect the CLiC device cable from the USB port.</li> <li>• Press the 'Y' key on the Keyboard to disable the CLiC device.</li> <li>• Contact a qualified service technician.</li> </ul>
<p>Crit-Line disabled. Must verify Crit-Line.</p>	<p>The CLiC device must be verified before it is available for use during treatment.</p>	<p>Advisory message</p>	<p>If this message is displayed <i>during the treatment</i>:</p> <ul style="list-style-type: none"> <li>• The CLiC device is not monitoring the patient. The CLiC device cannot be used until the next treatment.</li> </ul> <p>If the message is displayed <i>before the treatment starts</i>:</p> <ul style="list-style-type: none"> <li>• Place the CLiC device on the verification filter, which is attached to its USB cable.</li> <li>• Wait up to one minute for the message to clear. If the message clears, the CLiC device is verified.</li> <li>• If verification fails, select the "Test &amp; Options" screen-button and select the <b>Verify Crit-Line</b> button to initiate the verification process manually.</li> <li>• If the message is still not cleared, the CLiC device cannot be used for the dialysis treatment. Disconnect the CLiC device cable from the USB port and contact a qualified service technician.</li> </ul>
<p>Crit-Line needs verification</p>	<p>The CLiC device has not been verified within the past 30 days. The Hct/BV graph on the "Crit-Line" screen will be disabled.</p>	<p>Advisory message</p>	<p>Verify the CLiC device:</p> <ul style="list-style-type: none"> <li>• Place the CLiC device on the CLiC Verification Filter, which is attached to its USB cable.</li> <li>• Wait up to one minute for the message to clear. If the message clears, the CLiC device is verified.</li> </ul> <p>If the message is not cleared:</p> <ul style="list-style-type: none"> <li>• Select the "Test &amp; Options" screen-button then select the <b>Verify Crit-Line</b> button to start the verification process manually.</li> <li>• Wait up to one minute for the message to clear.</li> </ul> <p>If the message is still not cleared, the CLiC device cannot be used for the dialysis treatment.</p> <ul style="list-style-type: none"> <li>• Disconnect the CLiC device cable from the USB port.</li> <li>• Contact a qualified service technician.</li> </ul>

Message	Purpose of Message	Type	Action Required
Crit-Line: No Blood	The Tx Clock is running and the CLiC device no longer senses blood in the Crit-Line Blood Chamber.	Warning	<p>Check the Crit-Line Blood Chamber:</p> <ul style="list-style-type: none"> <li>• Make sure there is proper blood flow: There should be no air or bubbles in the chamber.</li> <li>• Make sure the CLiC device is properly seated on the Crit-Line Blood Chamber: The device should be placed perpendicularly over the chamber and cannot be rotated up or down.</li> </ul> <p>If the message is not cleared, the CLiC device cannot be used for the dialysis treatment.</p> <ul style="list-style-type: none"> <li>• Remove the device from the Crit-Line Blood Chamber.</li> <li>• Disconnect the CLiC device cable from the USB port and press the <b>RESET</b> key to disable the CLiC device.</li> <li>• Contact a qualified service technician.</li> </ul>
Crit-Line: No Comm	The 2008T hemodialysis machine has not received data from the CLiC device.	Warning	<p>Check the CLiC device's USB cable:</p> <ul style="list-style-type: none"> <li>• Make sure the cable is securely connected to the 2008T hemodialysis machine's USB port.</li> <li>• Wait up to one minute for the message to clear.</li> </ul> <p>If the message is not cleared, the CLiC device cannot be used for the dialysis treatment.</p> <ul style="list-style-type: none"> <li>• Disconnect the CLiC device cable from the USB port.</li> <li>• Press the 'Y' key on the Keyboard to disable the CLiC device.</li> <li>• Contact a qualified service technician.</li> </ul>
Crit-Line: Obstruction	Something is blocking the CLiC device's optical sensor.	Warning	<p>Check the Crit-Line Blood Chamber:</p> <ul style="list-style-type: none"> <li>• Remove the CLiC device from the blood chamber and check for obstructions.</li> <li>• Reattach the CLiC device to the blood chamber.</li> <li>• Wait up to one minute for the message to clear.</li> </ul> <p>If the message is not cleared, the CLiC device cannot be used for the dialysis treatment.</p> <ul style="list-style-type: none"> <li>• Remove the CLiC device from the Crit-Line Blood Chamber.</li> <li>• Disconnect the CLiC device cable from the USB port.</li> <li>• Press the <b>RESET</b> key to disable the CLiC device.</li> <li>• Contact a qualified service technician.</li> </ul>
Crit-Line on Filter?	To verify the CLiC device, the device must be clipped to its verification filter.	Advisory message	<p>Place the CLiC device on the CLiC Verification Filter, which is attached to its USB cable.</p>

Message	Purpose of Message	Type	Action Required
Crit-Line: System Error	System error.	Warning	<p>The CLiC device cannot be used for the dialysis treatment.</p> <ul style="list-style-type: none"> <li>• Disconnect the CLiC device cable from the USB port.</li> <li>• Press the <b>RESET</b> key to disable the CLiC device.</li> <li>• Contact a qualified service technician.</li> </ul>
Crit-Line Verified	The verification test was successful.	Advisory message	No action required. The CLiC device is ready for use during treatment.
Failed To Print	The CLiC device treatment report was not printed.	Warning	<p>Press the <b>RESET</b> key to clear the warning. Check the connections to the printer and try to print again. If unable to print, contact a qualified service technician.</p> <p> <b>Note:</b> If you press the <b>New TX</b> key and then press the <b>CONFIRM</b> key, the Crit-Line data for the completed treatment will be lost.</p>
Oxygen Saturation Low	The current Oxygen Saturation has dropped below the O <sub>2</sub> Alert Level set on the "Crit-Line" screen.	Alert	<p>Assess the patient for any changes in physiologic state.</p> <p>The alert can be cleared by setting the <b>O<sub>2</sub> Alert Level</b> button on the "Crit-Line" screen to OFF.</p> <ul style="list-style-type: none"> <li>• To turn the O<sub>2</sub> Alert level OFF, select the <b>O<sub>2</sub> Alert Level</b> button, enter "0" (zero) on the keyboard, and press the <b>CONFIRM</b> key.</li> </ul> <p> <b>Note:</b> At the direction of a physician, a new O<sub>2</sub> Alert Level can be selected.</p> <p>To change the O<sub>2</sub> Alert Level, select the <b>O<sub>2</sub> Alert Level</b> button, enter the desired value using the keyboard and press the <b>CONFIRM</b> key.</p>
Press Confirm to switch to Blood Pressure graph. Press Escape to return to O2 graph	The operator has selected the O <sub>2</sub> Sat graph field on the "Crit-Line" screen; the machine is prompting the operator to choose between displaying the BP graph or the O <sub>2</sub> Sat graph.	Advisory message	<p>Press the <b>CONFIRM</b> key to switch to the Blood Pressure graph.</p> <p>Or</p> <p>Press the <b>Escape</b> key to return to the Oxygen Saturation graph.</p>
Press Confirm to switch to O2 graph. Press Escape to return to BP graph.	The operator has selected the BP graph field on the "Crit-Line" screen; the machine is prompting the operator to choose between displaying the O <sub>2</sub> Sat graph or the BP graph.	Advisory message	<p>Press the <b>CONFIRM</b> key to switch to the Oxygen Saturation graph.</p> <p>Or</p> <p>Press the <b>Escape</b> key to return to the Blood Pressure graph.</p>

Message	Purpose of Message	Type	Action Required
Rel. Blood Volume Low	The current blood volume percentage or hematocrit has dropped below the BV Alert Level set on the "Crit-Line" screen. The UF pump has been turned off.	Alert	<p>Assess the patient for any changes in physiologic state. The alert can be cleared by setting the <b>BV Alert Level</b> button on the "Crit-Line" screen to OFF.</p> <ul style="list-style-type: none"> <li>To turn the BV Alert level OFF, select the <b>BV Alert Level</b> button, enter "0" (zero) on the keyboard, and press the <b>CONFIRM</b> key.</li> <li>After clearing the alert, the UF pump will automatically turn back on to the UF Rate set on the "Home" screen.</li> </ul> <p> <b>Note:</b> At the direction of a physician, a new BV Alert Level can be selected.</p> <p>To change the BV Alert Level, select the <b>BV Alert Level</b> button, enter the desired value using the keyboard and press the <b>CONFIRM</b> key.</p>
Verify Failed	The verification test shows that the CLiC device is not ready for use during treatment.	Advisory message	<p>Verify the CLiC device:</p> <ul style="list-style-type: none"> <li>Place the CLiC device on the CLiC Verification Filter, which is attached to its USB cable.</li> <li>Wait up to one minute for the message to clear. If the message clears, the CLiC device is verified.</li> </ul> <p>If the message is not cleared:</p> <ul style="list-style-type: none"> <li>Select the "Test &amp; Options" screen-button then select the <b>Verify Crit-Line</b> button. This will start the verification process manually.</li> <li>Wait up to one minute for the message to clear.</li> </ul> <p>If the message is still not cleared, the CLiC device cannot be used for the dialysis treatment.</p> <ul style="list-style-type: none"> <li>Disconnect the CLiC device cable from the USB port.</li> <li>Press the <b>RESET</b> key to disable the CLiC device.</li> <li>Contact a qualified service technician.</li> </ul>

# Service Mode



---

**Note:** This section describes setting Crit-Line screens and calibrating the CLiC device in Service Mode. It is strongly recommended that you contact a qualified service technician if any Service Mode changes must be made.

---

## Enabling the CLiC device in Service Mode

The Crit-Line option must be set to ‘Yes’ in Service Mode in order to use the CLiC device during a hemodialysis treatment. The Crit-Line option is located on the Service Mode “Options: Module Options” screen. Note that the BTM and BVM module options are unavailable if Crit-Line is selected.

## Selecting the Crit-Line Graph Type

The default “Crit-Line” screen graph is the BV (Blood Volume) Graph. To change the graph, enter the “Options: Module Options” screen in Service Mode and use the **Crit-Line Graph** button to choose between Hct (Hematocrit) and BV (Blood Volume) graphs. Press the **CONFIRM** key to confirm the selection.

## Calibrating the CLiC device

The CLiC device only needs calibration if verification fails in Dialysis Mode. Calibration may extend the usable life of the CLiC device. To calibrate the CLiC device, plug the CLiC device USB cable into the USB port on the right side of the 2008T hemodialysis machine display screen (located under the flap). Power on the 2008T hemodialysis machine into Service Mode and go to the “Options: Calibrate Monitor” screen. Select the **Crit-Line Calibration** screen-button to enter the “Crit-Line Calibration” screen. Follow the instructions on the screen:

1. After the initial message “Initializing CLiC...” clears, attach the CLiC device to the verification filter on its USB cable.
2. Enter the serial number printed on the verification filter by selecting the **Crit-Line S/N** button and using the keyboard. Note that the serial number is case-sensitive. Press **Enter** on the keyboard to continue.
3. Press the **CONFIRM** key to calibrate the CLiC device. After the message “Calibrating...” clears, the message “Calibration successful” should appear.

Do not disconnect the CLiC device at any time during the calibration process. If the message “Calibration failed” appears, disconnect the device and do not use it for treatment.



# Appendix

## Product Improvement Policy

The CLiC device was designed and built to comply with these product specifications. It is the intention of Fresenius USA Marketing, Inc. to improve products continuously, a process which may result in modifications to specifications or equipment produced in the future. Such product improvements shall not incur any obligation to make similar changes or improvements to equipment previously produced. These changes or improvements may or may not be applicable or usable with previously produced equipment. Where possible, improvements will be made available at reasonable prices. Any such improvement shall not be construed as corrections of any perceived deficiency.

## Warranty

SALE of the parts described or referenced herein is expressly conditioned upon the terms and conditions set forth below. Any additional or different terms or conditions set forth by the Purchaser to Fresenius USA Marketing, Inc., (herein called “the Company”) shall not be effective or binding, and the terms set forth herein shall not be modified or amended, unless assented to in writing by an authorized official of the Company located in Waltham, Massachusetts.

**LIMITED WARRANTY:** The Company warrants to the Purchaser that the equipment delivered is free from defects in material or workmanship for the periods specified below, provided the equipment is used and maintained in accordance with the original manufacturer's operating instructions:

The Crit-Line in a Clip (CLiC) device shall be warranted for three hundred and sixty-five (365) days from the date of purchase.

The Company will repair or replace, at its option, using new or reconditioned parts and/or assemblies, any parts subject to this warranty, which are proven defective in materials or workmanship. Such repair and replacement will be made without cost to the Purchaser, and the Company reserves the right to determine the location at which the repair or replacement will be accomplished. The Warranty does not apply to any equipment which is misused, abused, neglected, tampered with, damaged by accident, flood, fire, or other hazard, subjected to abnormal or unusual electrical or fluid stress, improperly installed or operated, or not maintained in accordance with the care instructions set forth in the operating manual for the equipment.

Routine maintenance is not covered under warranty. Modifications, alterations, installation and service by any other than a Fresenius USA Marketing, Inc. authorized representative may void the warranty.

WARRANTIES APPLICABLE TO EQUIPMENT EXTEND ONLY TO THE PURCHASER, AND ARE NOT ASSIGNABLE OR TRANSFERABLE, AND SHALL NOT APPLY TO AUXILIARY EQUIPMENT, OR DISPOSABLE ACCESSORIES. THE FOREGOING WARRANTY SHALL BE IN LIEU OF ANY OTHER WARRANTIES, EXPRESSED IMPLIED OR STATUTORY, RESPECTING THE EQUIPMENT OR ANY PARTS OR COMPONENTS THEREOF, AND THE COMPANY MAKES NO IMPLIED WARRANTY OF MERCHANTABILITY OR FITNESS FOR A PARTICULAR PURPOSE. THE PURCHASER'S SOLE AND EXCLUSIVE REMEDY IN CONTRACT, TORT, OR UNDER ANY OTHER THEORY AGAINST THE COMPANY RESPECTING THE EQUIPMENT AND ITS USE SHALL BE THE REPLACEMENT OR REPAIR OF THE EQUIPMENT AND ITS PARTS AS DESCRIBED ABOVE, AND NO OTHER REMEDY (INCLUDING, WITHOUT LIMITATION, CONSEQUENTIAL DAMAGES) SHALL BE AVAILABLE TO THE PURCHASER. The Company shall have no further obligation or liability with respect to the equipment or its sale, operation and use, and the Company neither assumes, nor authorizes the assumption of, any obligation or liability in connection with such equipment.

### CLiC Spare Parts

CLiC device	P/N CL10041001
Crit-Line Blood Chamber	P/N CL10041021
CLiC Holder	P/N 290760
Crit-Line Printer Client Kit	P/N 190929
Crit-Line Printer Server Kit	P/N 190930



---

**Note:** Call Fresenius Medical Care Customer Service Spare Parts at (800) 227-2572.

---

### Additional Information

For more information, please contact:

<b>Fresenius USA, Inc.</b>	Manufactured by Fresenius USA, Inc. - Kaysville
4040 Nelson Avenue	695 North 900 West
Concord, CA 94520	Kaysville, Utah 84037
(800) 227-2572	(800) 546-5463

## Crit-Line in a Clip Specifications

Dimensions	1.75”H, 1.00”W, 3.00”L		
Weight	0.25 lbs.		
Cable length	42”		
Operating Temperature	50 °F to 104 °F (10 °C to 40 °C) Unit will be warm to the touch during use (max. 55.3 °C @ 40 °C ambient)		
Storage and Transportation Temperature	-40 °F to 257 °F (-40 °C to 125 °C)		
Oxygen Saturation Instrument Range & Accuracy	@ Hct	Accurate within ± 3%	Accurate within ± 5%
	45 – 60	60 – 100	50 – 100
	20 – 45	50 – 100	30 – 100
	10 – 20	Not Specified	40 – 100
Hematocrit Instrument Range & Accuracy	10 Hct – 60 Hct: ± 1 Hct SD		
Power	5 VDC / MAX 0.36A, USB bus powered		
Water Ingress Protection	IPX0 (CLiC device) IPX1 (2008T hemodialysis machine)		
Anesthetic Suitability	Not suitable		
Modes of Operation	Continuous or Standby		

**Note:** The CLiC device is a Clinical Laboratory Improvement Amendment (CLIA) exempt instrumentation device

## Manufacturer's Electromagnetic Compatibility (EMC) Declaration

Medical electrical equipment needs special precautions regarding electromagnetic compatibility (EMC) and needs to be installed and put into service according to the EMC information provided herein.

<b>Guidance and manufacturer's declaration – electromagnetic emissions</b>		
The 2008T hemodialysis machine is intended for use in the electromagnetic environment specified below. The customer or user of the 2008T hemodialysis machine should ensure it is used in such an environment.		
<b>Emissions test</b>	<b>Compliance</b>	<b>Electromagnetic environment – guidance</b>
RF Emissions CISPR 11	Group 1	The 2008T hemodialysis machine uses RF energy only for its internal functions. Therefore, its RF emissions are very low and are not likely to cause any interference in nearby electronic equipment.
RF Emissions CISPR 11	Class A	The 2008T hemodialysis machine is suitable for use in all establishments other than domestic and those directly connected to the public low-voltage power supply network that supplies buildings used for domestic purposes.
Harmonic emissions IEC 61000-3-2	Not applicable	
Voltage fluctuations/ flicker emissions IEC 61000-3-3	Not applicable	

<b>Guidance and manufacturer's declaration – electromagnetic immunity</b>			
The 2008T hemodialysis machine is intended for use in the electromagnetic environment specified below. The customer or the user of the 2008T hemodialysis machine should assure that it is used in such an environment.			
<b>Immunity test</b>	<b>IEC 60601 test level</b>	<b>Compliance level</b>	<b>Electromagnetic environment – guidance</b>
Electrostatic discharge (ESD) IEC 61000-4-2	±6 kV contact ±8 kV air (Level 3)	±6 kV contact ±8 kV air (Level 3)	Floors should be wood, concrete, or ceramic tile. If floors are covered with synthetic material, the relative humidity should be at least 30%.
Electrical fast transient/burst IEC 61000-4-4	±2 kV for power supply lines ±1 kV for input/output lines	±2 kV for power supply lines ±1 kV for input/output lines	Mains power quality should be that of a typical commercial and/or hospital environment.
Surge IEC 61000-4-5	±1 kV line(s) to line(s) ±2 kV line(s) to earth	±1 kV line(s) to line(s) ±2 kV line(s) to earth	Mains power quality should be that of a typical commercial or hospital environment.
Voltage Dips, short interruptions, and voltage variation on power supply input lines IEC 61000-4-11	<5 % $U_T$ (>95 % dip in $U_T$ ) for 0.5 cycles  40 % $U_T$ (60 % dip in $U_T$ ) for 5 cycles  70 % $U_T$ (30 % dip in $U_T$ ) for 25 cycles  <5 % $U_T$ (>95 % dip in $U_T$ ) for 5 seconds	<5 % $U_T$ (>95 % dip in $U_T$ ) for 0.5 cycles  40 % $U_T$ (60 % dip in $U_T$ ) for 5 cycles  70 % $U_T$ (30 % dip in $U_T$ ) for 25 cycles  <5 % $U_T$ (>95 % dip in $U_T$ ) for 5 seconds	Mains power quality should be that of a typical commercial or hospital environment. If the user of the 2008T hemodialysis machine requires continued operation during power mains interruptions, it is recommended that the 2008T hemodialysis machine be powered from an uninterruptible power supply or a battery.
Power-Frequency (50/60 Hz) magnetic field IEC 61000-4-8	3 A/m	3 A/m	Power frequency magnetic fields should be at levels characteristic of a typical location in a typical commercial or hospital environment.
NOTE $U_T$ is the a.c. mains voltage prior to application of the test level.			

**Guidance and manufacturer's declaration – electromagnetic immunity**

The 2008T hemodialysis machine is intended for use in the electromagnetic environment specified below. The customer or the user of the 2008T hemodialysis machine should assure that it is used in such an environment.

<b>Immunity test</b>	<b>IEC 60601 test level</b>	<b>Compliance level</b>	<b>Electromagnetic environment – guidance</b>
Conducted RF IEC61000-4-6	3 Vrms 150 kHz to 80 MHz	3 Vrms 150 kHz to 80 MHz	<p>Portable and mobile RF communications equipment should be used no closer to any part of the 2008T hemodialysis machine, including cables, than the recommended separation distance calculated from the equation applicable to the frequency of the transmitter.</p> <p>If abnormal performance is observed such as TMP alarms or blood leak alarms, additional measures may be necessary, such as re-orienting or relocating the equipment.</p> <p><b>Recommended separation distance</b>  <math>1.2 \sqrt{P}</math></p> <p><math>1.2 \sqrt{P}</math> 80 MHz to 800 MHz  <math>2.3 \sqrt{P}</math> 800 MHz to 2.5 GHz</p> <p>where P is the maximum output power rating of the transmitter in watts (W) according to the transmitter manufacturer and d is the recommended separation distance in meters (m).</p> <p>Field strengths from fixed RF transmitters, as determined by an electromagnetic site survey,<sup>a</sup> should be less than the compliance level in each frequency range.<sup>b</sup></p> <p>Interference may occur in the vicinity of High Frequency Surgical Equipment (such as electrocautery devices) or other intentional radio frequency emitting equipment typically marked with the following symbol:</p> 
Radiated RF IEC 61000-4-3	3 V/m 80 MHz to 2.5 GHz	3 V/m 80 MHz to 2.5 GHz	

NOTE 1 At 80 MHz and 800 MHz, the higher frequency range applies.

NOTE 2 These guidelines may not apply in all situations. Electromagnetic propagation is affected by absorption and reflection from structures, objects, and people.

<sup>a</sup> Field strengths from fixed transmitters, such as base stations for radio (cellular/cordless) telephones and land mobile radios, amateur radio, AM and FM radio broadcast and TV broadcast cannot be predicted theoretically with accuracy. To assess the electromagnetic environment due to fixed RF transmitters, an electromagnetic site survey should be considered. If the measured field strength in the location in which the 2008T hemodialysis machine is used exceeds the applicable RF compliance level above, the 2008T hemodialysis machine should be observed to verify normal operation. If abnormal performance is observed, additional measures may be necessary, such as re-orienting or relocating the 2008T hemodialysis machine.

<sup>b</sup> Over the frequency range 150 kHz to 80 MHz, field strengths should be less than 3 V/m.

<b>Recommended separation distances between portable and mobile RF communications equipment and the 2008T hemodialysis machine</b>			
The 2008T hemodialysis machine is intended for use in an electromagnetic environment in which radiated RF disturbances are controlled. The customer or the user of the 2008T hemodialysis machine can help prevent electromagnetic interference by maintaining a minimum distance between portable and mobile RF communications equipment (transmitters) and the 2008T hemodialysis machine as recommended below, according to the maximum output power of the communications equipment.			
<b>Rated maximum output power of transmitter W</b>	<b>Separation distance according to frequency of transmitter m</b>		
	<b>150 kHz to 80 MHz</b>	<b>80 MHz to 800 MHz</b>	<b>800 MHz to 2.5 GHz</b>
	$d = 1.2 \sqrt{P}$	$d = 1.2 \sqrt{P}$	$d = 2.3 \sqrt{P}$
0.01	0.12	0.12	0.23
0.1	0.38	0.38	0.73
1	1.2	1.2	2.3
10	3.8	3.8	7.3
100	12	12	23
For transmitters rated at a maximum output power not listed above, the recommended separation distance d in meters (m) can be estimated using the equation applicable to the frequency of the transmitter, where P is the maximum output power rating of the transmitter in watts (W) according to the transmitter manufacturer.			
NOTE 1 At 80 MHz and 800 MHz, the separation distance for the higher frequency range applies.			
NOTE 2 These guidelines may not apply in all situations. Electromagnetic propagation is affected by absorption and reflection from structures, objects, and people.			

### **CDX System Wifi Adapter**

#### IEEE802.11b/g Adapter

Radio Frequency (RF): 2.412 Ghz to 2.462 Ghz

Power: 61mW

Modulation: Direct Sequence Spread Spectrum, Orthogonal Frequency Division Multiplexing

#### IEEE802.11b/g/n dual band Adapter

Radio Frequency (RF): 2.412 Ghz to 2.462 Ghz, 5.18 Ghz to 5.825 Ghz

Power: 110mW

Modulation: Direct Sequence Spread Spectrum, Orthogonal Frequency Division Multiplexing

### **CLiC Wireless Printer**

Radio Frequency (RF): 902.217 Mhz to 927.492 Mhz

Power: 52mW

Modulation: Frequency Hopping Spread Spectrum Frequency Shift Keying



**Indications for Use:** The 2008T machine is indicated for acute and chronic dialysis therapy. The CLiC device is used with the 2008T hemodialysis machine to non-invasively measure hematocrit, oxygen saturation and percent change in blood volume. The CLiC device measures hematocrit, percent change in blood volume and oxygen saturation in real time for application in the treatment of dialysis patients with the intended purpose of providing a more effective treatment for both the dialysis patient and the clinician. Based on the data that the monitor provides, the clinician/nurse, under physician direction, intervenes (i.e., increases or decreases the rate at which fluid is removed from the blood) in order to remove the maximum amount of fluid from the dialysis patient without the patient experiencing the common complications of dialysis which include nausea, cramping and vomiting. The CLiC blood chamber is a sterile, single use, disposable, optical cuvette designed for use with the CLiC monitor's sensor clip during acute and chronic hemodialysis therapy to non-invasively measure hematocrit, percent change in blood volume and oxygen saturation. The blood chamber is connected between the arterial bloodline and the dialyzer within the extracorporeal circuit during the hemodialysis treatment.

**Caution:** Federal (US) law restricts these devices to sale by or on the order of a physician.

**Note:** Read the Instructions for Use for safe and proper use of these devices. For a complete description of hazards, contraindications, side effects and precautions, see full package labeling at [www.fmcna.com](http://www.fmcna.com).